

## DESCRIPTION

Classic range consisted of three different ranges of profiles, identical in geometry and types, but different in their depth, that classified them into large, medium and small. Depending on the dimensions of the window, the most appropriate series was selected from a static point of view. These three ranges were able to cover any type of window and in combination with special T-profiles, used as mullions and transoms, for the first time it was also possible to realize curtain walls of any size.

The currently available range was revised in 1964. The three separate ranges were condensed to one medium range, which consisted of 20 profiles able to cover the needs of new windows as well as replace those in historic buildings. Over the decades, some profiles have been abandoned and some new ones have been added, making the range more and more versatile. The depth of the profiles 32 and 37 mm, allows to manufacture various types of openings in different styles, both with single glazing or double glazing with a maximum thickness of 20 mm. Even today, this series is still chosen for a great number of restoration projects worldwide, where the superintendence asks for the original design and proportions of the relevant epoch.

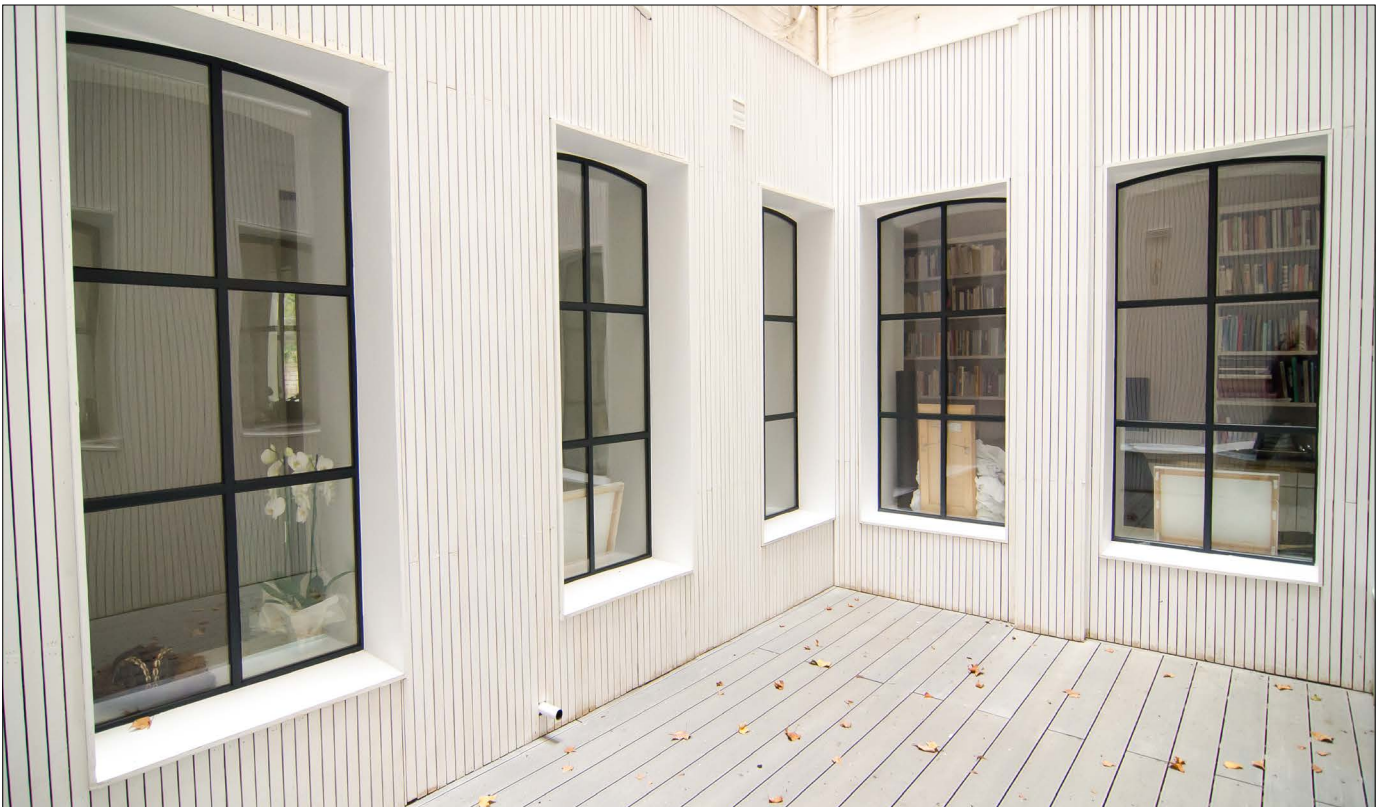

## TECHNICAL DATA

1. Solid hot rolled profiles.
2. "Stepped leg" design.
3. Material thickness up to 5 mm.
4. Very compact profiles with minimal depth and sightlines.
5. Self-adhesive non-shrinking gaskets.
6. Low emissivity double-glazing up to 20 mm.
7. Choice of different glazing beads.
8. Appropriate for heavy-duty corrosion protection.

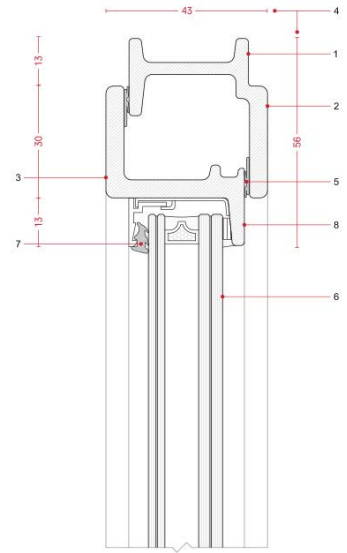

## GLAZING

All our Classic W20 windows are internally beaded for enhanced security

All windows have 20mm double glazed unit with a U-value 1,2W/m<sup>2</sup>K and in standard comes with low emission coating







Within required by Building Regulation areas included is safety glazing

We also offer additionally ranges of coloured, toughened, laminated glass for extra security. Some other available glass options:

- Acoustic
- Solar control
- Self cleaning
- Digital print units
- Ornamental



## TEST CENTRE

| Norm  | Test                    |  |  |  |
|---|-------------------------|---|---|---|
|   |                         | Inward opening  | Outward opening   | Inward opening  |
| <b>EN12208</b><br> | Watertightness          | up to Class 9A - 600 Pa   | up to Class 9A - 600 Pa   | up to Class 6A/7B - 300 Pa  |
| <b>EN12210</b><br> | Resistance to wind load | up to Class C5 - 2000 Pa  | up to Class C5 - 2000 Pa  | up to Class C3 - 1200 Pa  |
| <b>EN12207</b><br> | Air permeability        | up to Class C4 - 600 Pa   | up to Class C4 - 600 Pa   | up to Class C4 - 600 Pa   |

